

White MDF

The tradesman's essential guide



another **trade essential** from
THE laminex GROUP™

White MDF

The tradesman's essential guide



Trade Essentials® White MDF is a high quality medium density fibreboard with a white melamine surface bonded to both sides. The melamine surface is non-porous and hardwearing making it ideal for cabinetry.

And it makes building cabinetry fast and easy. As the board is pre-decorated, all you do is cut, drill and edge it.

White MDF is also very versatile, as the MDF core allows the panel to be used as a pre-finished product, or face routed and finished with a paint system where required.

White MDF is a versatile panel that can be used for making cabinets, wardrobes, or shelving.

Renewable, sustainable resource

The reconstituted wood fibres used to make White MDF are obtained from Australian pine plantations – a sustainable

renewable resource. In fact only renewable plantation timber is used in the manufacture of White MDF.

White MDF allows you to achieve fast, cost effective cabinetry results without destroying our precious wilderness or the rainforests of other countries.

Applications

White MDF is available in Moisture Resistant and Standard grades and a select range of thicknesses, sheet sizes and finishes to suit a wide range of applications.

MDF is a wood based panel and reacts to changes in moisture like natural timber, ie. High or low humidity will cause some expansion or contraction without any effect on the strength of the board. Specific applications are detailed separately on the following pages.

White MDF MR

White MDF MR is a highly moisture resistant medium density fibreboard with a hardwearing white melamine surface bonded to both sides. It is suitable for use in areas of high humidity, or where accidental exposure to moisture may occur.

The highly moisture resistant properties of White MDF MR are due to the bonding of the wood fibres with a specially formulated moisture resistant resin.

Applications

White MDF MR is designed for interior use in the following applications:

Kitchen cupboards, bathroom vanities, laundry cupboards, shelving, built in cupboards, wardrobes and furniture, wall linings and all detailed joinery where a moisture resistant decorative board is required.

Moisture resistance

White MDF MR complies with the Wet Cyclic Test for moisture resistance properties as specified in Table 4.2 of AS/NZS1859.2.

Surface finishes

Décor Texture, Velvet and Satin finishes.

Note: White MDF Satin Finish: the surface is suited to professionally prepared 2-pack polyurethane or similar coating systems. Water based paints do not tend to bond easily to melamine surfaces and as such, the use of acrylic or domestic oil based paint is not recommended. In all applications, the painting of melamine panels should be referred to a reputable paint-trade professional. To achieve the best 2-pack polyurethane finish, recommendation is the use of undercoat on the painted surfaces prior to the final finishing coats being applied. The Laminex Group accepts no responsibility for the paint finish on the white melamine surface.

Decorative surface properties

When tested in an approved manner, White MDF complies with the relevant sections of AS/NZS 1859.3 for surface properties as follows:

Resistance to wear

Typical results 600 cycles.

Resistance to steam

No noticeable effects after one hour exposure.

Substrate Physical Properties

(# Typical physical properties when tested to AS/NZS 1859.2)

Property	Unit	Board Thickness			
		9mm	12mm	16mm-18mm	25mm
Board Density	kg/m ³	760	750	735	710
Internal Bond	kPa	1000av	1000av	900av	800av
Modulus of Rupture	MPa	42av	42av	40av	35av
Modulus of Elasticity	MPa	3500av	3500av	3500av	3200av
Screw Holding – Face	N	N/A	N/A	800av	800av
Screw Holding – Edge	N	N/A	N/A	1400av	1400av
Surface Soundness	MPa	1.0	1.2	1.6	1.8
Moisture Content	%	6-9	6-9	6-9	6-9
Thickness Swell 24hr	%	10	8	6	5av
Moisture Resistance	Test	V313	V313	V313	MOR A

In most instances the performance characteristics of the MDF exceeds the minimum requirement of AS/NZS 1859.2. However for minimum property values refer to AS/NZS 1859.2.

Board Weight

Unit	(Kg/m ²)
9mm	6.8
12mm	9.0
16mm	12.0
18mm	13.0
25mm	18.0
32mm	23.0

Fire Hazard Indices

(Typically achieved when tested to AS/NZS 1530.3)

Indices	Result	Range
Ignitability	14	0 - 20
Spread of Flame	8	0 - 10
Heat Evolved	7	0 - 10
Smoke Developed	3	0 - 10

White MDF Standard

White MDF STD is a high quality MDF substrate with a hardwearing white melamine surface bonded to both sides.

The MDF substrate is made up of wood fibres bonded together with a specially formulated durable resin. It has a light compact core that allows clean machining.

Applications

White MDF STD is designed for interior use for the following applications:

Built in cupboards, wardrobes and furniture, shelving, wall linings and all detailed joinery where the product will not be exposed to damp conditions or high humidity.

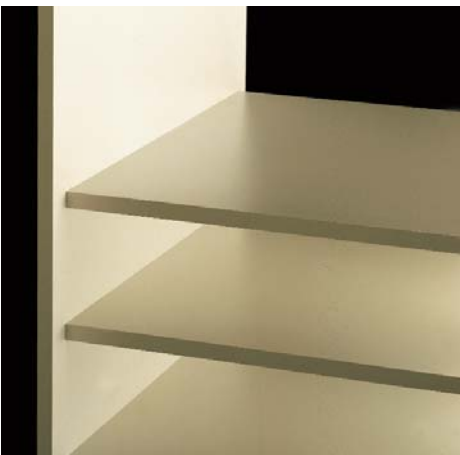

Surface finishes

Décor Texture, Velvet and Satin finishes.

Note: White MDF Satin Finish: the surface is suited to professionally prepared 2-pack polyurethane or similar coating systems. Water based paints do not tend to bond easily to melamine surfaces and as such, the use of acrylic or domestic oil based paint is not recommended. In all applications, the painting of melamine panels should be referred to a reputable paint-trade professional. To achieve the best 2-pack polyurethane finish, recommendation is the use of undercoat on the painted surfaces prior to the final finishing coats being applied. The Laminex Group accepts no responsibility for the paint finish on the white melamine surface.

Decorative surface properties

When tested in approved manner complies with the relevant sections of AS/NZS 1859.3 for surface properties as follows:

Resistance to wear

Typical results 600 cycles.

Resistance to steam

No noticeable effects on the surface after one hour exposure.

Physical Properties

(Typical physical properties when tested to AS/NZS 1859.2)

Property	Unit	Board Thickness			
		9mm	12mm	16mm-18mm	25mm-32mm
Board Density	Kg/m ³	760	750	735	710
Internal Bond	KPa	800av	800av	800av	700av
Modulus of Rupture	MPa	36av	36av	34av	32av
Modulus of Elasticity	MPa	3300av	3300av	3300av	3100av
*Screw Holding – Face	N	N/A	N/A	700av	800av
*Screw Holding – Edge	N	N/A	N/A	1000av	900av
Surface Soundness	MPa	0.7	0.9	1.2	1.4
Moisture Content	%	6-9	6-9	6-9	6-9
Thickness Swell 24hr	%	15	11	9	8

*Values reflect new testing methods for screw holding properties in AS/NZS 4266.13.

Board Weight

Unit	(Kg/m ²)
9mm	6.8
12mm	9.0
16mm	12.0
18mm	13.0
25mm	18.0
32mm	23.0

Fire Hazard Indices

(Typically achieved when tested to AS/NZS 1530.3)

Indices	Result	Range
Ignitability	14	0 - 20
Spread of Flame	8	0 - 10
Heat Evolved	7	0 - 10
Smoke Developed	4	0 - 10

Thin White Edgings

There are two types of Trade Essentials® continuous Thin White Edgings:

1. Melamine Edging is constructed from decorative papers impregnated with melamine thermosetting resins to give a thin durable surface that ensures high wear and stain resistance. White Melamine Edging is supplied in continuous rolls pre-glued with a hot melt or unglued for bonding with hot melts.
2. PVC Edging is a tough, flexible polymer edging extruded in continuous lengths. Because of the nature of the material, PVC Edging will resist chipping and splintering. White PVC Edging is supplied in continuous rolls unglued for bonding with hot melts.

Applications

Trade Essentials® Thin White Edgings are recommended for the edge treatment of White MDF, and decorated white board products. Thin White Edgings are used for edging shelving, cabinets and built in cupboard panels.

For decorative, high wear applications such as doors, end panels, bench tops and display panels, thicker melamine or rigid ABS edgings are recommended.

A broad range of decorative edgings are available from the Laminex® and Formica® product ranges.

Finishes

Trade Essentials® Thin White Edgings are available in two finishes, Stipple and Velvet.

Stipple finish is suitable for use with Décor texture panel finish, while Velvet finish is suitable for use with both Velvet and Satin panel finishes.

Sizes

Trade Essentials® Thin White Edgings are available in two widths; 19mm wide Edging is suitable for 16mm thick panels only, whilst 21mm wide Edging is suitable for both 16mm and 18mm thick panels.

For roll sizes and product options please contact your local branch of The Laminex Group.

Storage and handling

Storage and handling of White MDF panel products

The following recommendations should be applied to maintain White MDF panels in good order and condition. The storage area should be protected from the sun, rain and wind. Open sided sheds would not be regarded as dry stores.

All packs should be evenly supported at each end at intervals of not more than 750mm where the packs are multiple stacked, and no further than 150mm from the edge of boards. All supports should be vertically aligned.

Keep work area clean. Avoid contact with abrasive surfaces or grit.

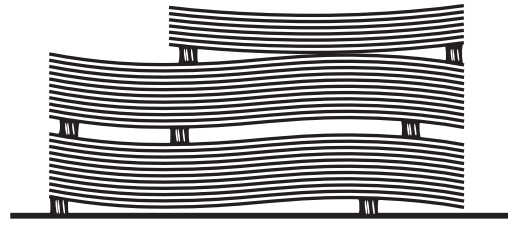

Incorrect storage method

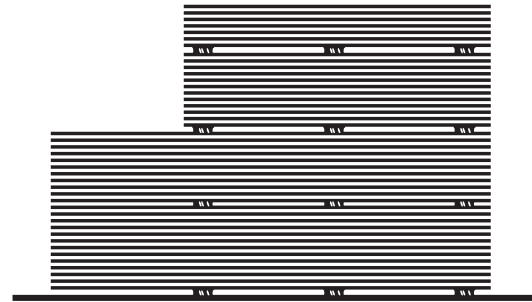

Correct storage method

Equilibrium Moisture Content

The Laminex Group dispatches White MDF panels with a moisture content of between 5% to 8%. This can alter during the time the boards are in transit or storage. The relative humidity of the environment where the boards are to be fixed may require quite a different moisture content.

Conditioning panels is recommended to ensure that they attain an equilibrium moisture content (EMC), in line with ambient humidity, before fixing, so as to reduce the likelihood of bowing after installation. Any subsequent movement will be a drying shrinkage which, given adequate support and fixings, keeps the boards flat and taut.

Some boards may achieve an EMC simply by being stored for some time in the location where they are to be used without any specific conditioning.

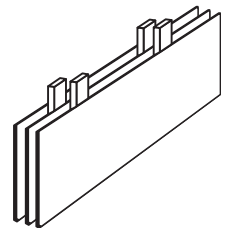

Conditioning in air

The Laminex Group suggests conditioning boards before installation. This involves exposing the boards in the room where they are to be fixed for long enough to allow them to reach a moisture content which is in balance with the board surroundings and adjusts the board dimensions accordingly.

To encourage free air circulation over all board surfaces, the boards should be arranged loosely as shown above, either vertically or horizontally. They should then be allowed to stand like this for a minimum of 48 hours.

Fabrication

Machining

White MDF panels can be cut, drilled and machined using standard wood working equipment fitted with tungsten carbide tipped cutting edges.

It is recommended that the material be cut on a bench type or beam saw, using a 300mm tungsten tipped blade with 72 to 96 teeth. For pre-laminated board such as White MDF a triple chip saw blade should protrude 20-30mm above the surface of the board.

Note: All decorated panels should be cut only on saws that have a scribing blade on the underside. Work piece must be firmly fixed. Observe all professional machining safety practices.

Adhesives and bonding

When gluing dowels or biscuits to the core of White MDF panels, a high solids PVA with good gap filling properties is suitable. **Trade Essentials® General Purpose PVA** is recommended for this application.

However, when gluing timber and other wood panels to the White MDF surface an adhesive melamine board is recommended (such as AV56).



Dowel joints

Dowel joints are one of the most common adhesive based furniture assembly joints. Dowelling is a simple, inexpensive, strong and reliable way of making a butt or mitre joint.

Machining dowel holes

Dowel holes should be cleanly machined with all loose particles blown from the holes. If a blunt drill is used the drill will overheat and polish the inside of the hole and reduce the ability of the adhesive to bond.

Dowel diameter

Dowels used should be no thicker than 50% of the thickness of the panel used.

Hole diameter

The fit of the dowel in the hole is critical to withdrawal strength. Holes drilled in the edges should be just a firm push-in fit to prevent the edge of the board from splitting as the dowels expand due to moisture uptake from the adhesive. Dowels inserted into the face of a panel should be a firm knock-in fit.

Dowel and Dowel Hole Diameters		
Board Thickness (mm)	Dowel Diameter (mm)	Dowel Hole Diameter (mm)
12 to 15	6	6.2
16 to 24	6 to 8	6.2 to 8.2
25 or more	10	10.2

Gluing

When using dowel joints only the dowels are glued in place. The practice of using glue between the edge and the face may actually weaken the joint.

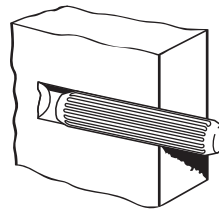

Interference fit (not recommended)

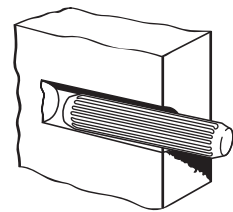

Clearance 0.1mm all round (preferred)

Depth

Inserting the dowel to the proper depth is important. They should be inserted at least 25mm into the edge of the White MDF panel and as deep as practical into the face surface, but no more than two thirds of the thickness. In general, the longer the dowel the stronger the joint.

Dowel selection

Dowels with multiple longitudinal or spiral groove patterns are recommended to ensure uniform adhesive spread within the joint. The dowels should be cleanly machined and free from any loose or torn fibres. The moisture content of dowels at the time of assembly should be in the range 10% +/-2%.



Smooth dowel (not recommended)

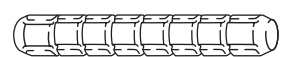

Grooved dowels (preferred)

Mechanical fixing

Selecting screw type and length

Quality parallel threaded screws are recommended for White MDF.

The length of the screw directly affects the holding power of the screws, for example, a 25mm screw has twice the holding power of a 13mm screw. This is most important when screwing into the edge of White MDF panels.

Selecting screw diameter

To avoid splitting the panel when screwing into the edge, the screw diameter should not exceed 20% of the panel thickness. For example, the maximum screw diameter for 16mm board is 6 gauge. Please see tables below.

Countersunk - Recessed Head Parallel Shank

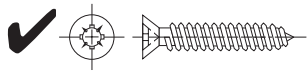

(recommended screw type)

Countersunk - Slotted Head Traditional Wood Screw

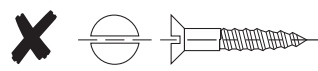

(not recommended)

Pilot holes

Correct pilot holes are essential to avoid splitting. The pilot holes should be approximately 80% of the screw core diameter. Do not over tighten screws, as further turning after the screw is tight will reduce holding power.

Screw Pilot Hole Selection		
Recommended Screw Gauge	Pilot Hole Diameter	Thickness
4	2.0mm	9mm
5	2.4mm	12mm
6	2.6mm	16mm
7	2.7mm	18mm
8	3.0mm	25mm
9	3.3mm	32mm

Maximum Screw Gauge Selection					
Thickness	The Maximum Recommended Screw Gauge to Thickness of White MDF				
	4	5	6	7	8
9mm	-	-	N/R	N/R	N/R
12mm	Yes	Yes	N/R	N/R	N/R
16mm	Yes	Yes	Yes	N/R	N/R
18mm	Yes	Yes	Yes	Yes	Yes
25mm	Yes	Yes	Yes	Yes	Yes
32mm	Yes	Yes	Yes	Yes	Yes

N/R = Not Recommended

Screw location

Screws should be carefully positioned to prevent splintering and breakout – no closer than 25mm to a corner and no closer than 12mm to the edge. When a long line of screws has to be used, it is a good idea to stagger the screws to prevent splitting the substrate being screwed to. When screwing into the edge, never place a screw closer than 75mm from the end of the panel.

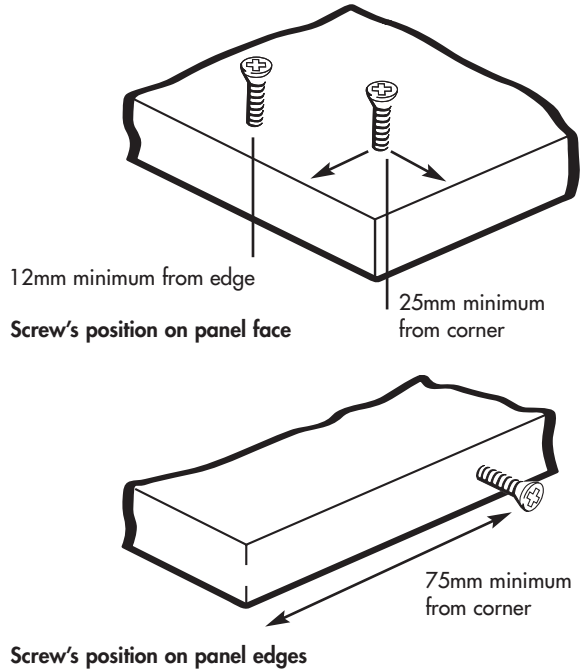

White MDF shelf loading

Applications for shelving are wide and varied and it is recommended that all designers carry out their own full load analysis based on their specific applications. It is worth noting that the shelf loading ability of White MDF is slightly better than that of White decorated Particleboard. For a guide to shelf loadings for MDF refer to the Trade Essentials® Craftwood® brochure.

Safety and handling

White MDF is a reconstituted wood product containing wood, resin and wax. Machine tools should be fitted with dust extractors and the wearing of a dust mask and eye protection is recommended. Material Safety Data Sheets for White MDF are available on request from any branch of The Laminex Group.

Trade Essentials®

Product Range

- Adhesives • Craffform® • Craftwood®
- Particleboard • Particleboard Flooring
- Whiteboard • White MDF

White MDF is marketed, distributed and manufactured in Australasia by The Laminex Group

The information contained in this technical publication is intended to give a general indication of the characteristics of the material. While all possible care has been taken to ensure that the information is correct, the manufacturer cannot accept any liability, nor is any liability on the part of the manufacturer to be implied as a result of the data given. All measurements shown are in millimetres and nominal unless otherwise stated. The information contained in this publication supersedes all previous information and is subject to alteration without notice.

For sales enquiries please call The Laminex Group Customer Service Centre on 132 136

For more information including sheet sizes and product availability, visit www.thelaminexgroup.com.au

® and ™ are trade marks of The Laminex Group
A division of Laminex Group Limited
ABN 98 004 093 092
© Laminex Group Limited
7/07 advanz

another **trade essential** from
THE laminex GROUP™