

Laminex®

FormWrap™ Doors



Laminex® FormWrap™ Doors

Laminex® FormWrap™ Doors and Panels offer a welcome combination of affordability and design. A perfect addition to any home or commercial space, Laminex FormWrap Doors and Panels are available in a range of colours, finishes and profiles; ensuring that your space reflects your personal style.

Our Core Range offers a selection of matching Laminex decorated panels, providing an economical solution to meet your design requirements. Laminex FormWrap colours are also easy to mix and match with the broader Laminex Colour Collection, giving you almost endless options to create a striking design aesthetic.

Hard-wearing, easy to clean and with soft and smooth lines, this range is backed by the Laminex 7 year limited warranty, ensuring you peace of mind. So to get a designer look, without breaking the bank, look no further than Laminex FormWrap Doors & Panels.

7 YEAR LIMITED WARRANTY.

Laminex FormWrap Doors Features



Vertical
Application



Dimensional
Stability



Heat
Resistant



Water
Repellent



UV Stable
Indoor Use

Laminex® FormWrap™ Colour Range

Core Range



Polar White
G,S,FT

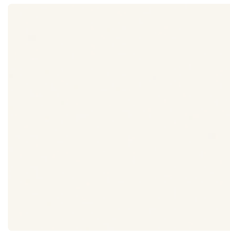

Ghostgum
G,S

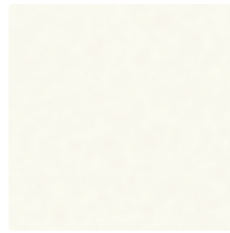

White
G,S,FT



Parchment
G,S



Alabaster
G,S

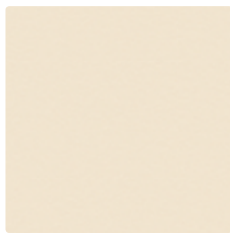

Moleskin
G

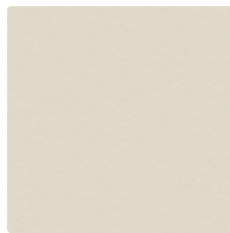

Sarsen Grey
G,S

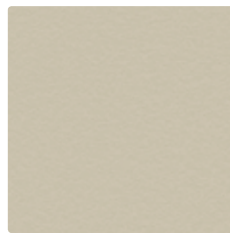

Paper Bark
G

Designer Range

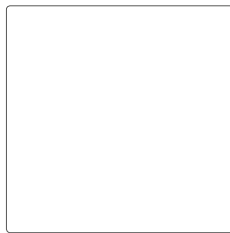

True White
G,S

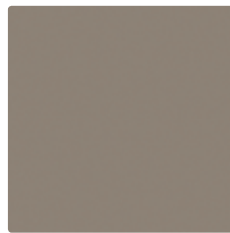

Daybreak
M

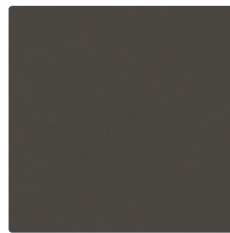

Afternoon Shade
M



Battalion
S



Nightfall
M

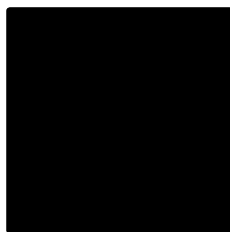

Black
G,S,T

Standard Offer: Laminex FormWrap Doors and Panels are manufactured using 18mm E0 MR MDF substrate and are available in all colours and finishes as specified above. Due to slight variations in manufacturing conditions, minor colour variations from the original sample may occur. Please obtain a copy of the Laminex FormWrap 7 Year Limited Warranty from www.laminex.com.au. Panel size dimensions: Min and Max panel size dimensions vary by profile. Please refer to the dimensions chart available with every order form or download from www.laminex.com.au. FINISH: G = Gloss, M = Matte, S = Satin, T = Texture and FT = Fine Texture. COVER IMAGE: Benchtop: **Essastone** in White **Concrete Matte** finish. Cabinetry: **Laminex FormWrap doors** in Polar White Satin finish with a Classic 2mm profile.

Laminex® FormWrap™ Door Profile Range

Flat Faced Doors

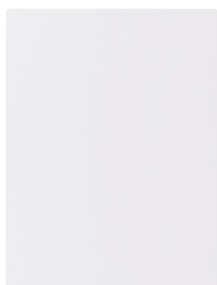

Classic Square Edge^

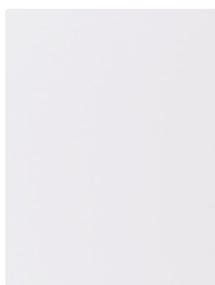

Classic 2mm Edge

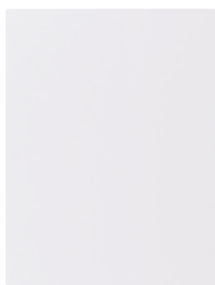

Classic 6mm Edge



Classic Bevelled Edge

Face Routed Doors



Heritage



Provincial



New Luxury Tudor



New Luxury Arch



Country V
NEW



Homestead



Country Square



Country Arch

Pocket Routed Doors



Settler*



Settler Planked*

All Face Routed and Pocket Routed Doors are shown here as Square outer edge profiles and are also available in 2mm and 6mm. Cross Section sketches not shown to scale. *Not available in gloss finish. ^ Finger pull option available and attracts a higher price.

Laminex® FormWrap™ Glazed Door Frames

Frames



Outer Edge Profiles

All doors and glazed frames come with an option of 2mm, 6mm or Square edge profile. The Bevelled edge profile is available in the Flat Face Classic only. The Finger Pull option is available in the Classic Square edge only.

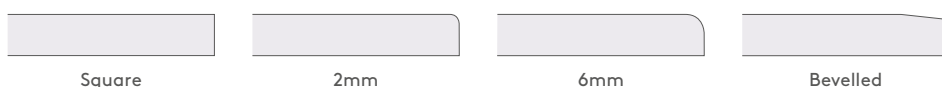

Recessed Handle

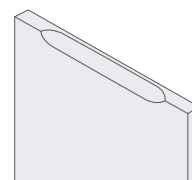

Frames are manufactured as per corresponding outer edge profile and internal rout profile with chosen Door Profile. Glass panel not included on Glazed Frames. † Not available for Pocket Routed profiles. ◇ Finger pull option only available in Classic Square Edge door profile and attracts a higher price. Base cabinetry: **Laminex FormWrap doors in Battalion** Satin finish. Overhead cabinetry: **Laminex FormWrap doors in Polar White** Satin finish. Both feature a Settler profile. Kitchen by Henley Homes.



Cabinetry: **Laminex FormWrap** doors in **Polar White** Satin finish with a **Settler** profile. Benchtops: **Essastone Unique Calacatta** Honed finish. Interior Design by Lydia Maskiell.



Laminex® FormWrap™ Drawers

Drawer Layouts

For beautiful feature detail, maintain your chosen profile to each drawer by opting for a Drawer Set. For the more contemporary integrated look, choose a drawer bank style that matches your adjoining doors.



Drawer Set

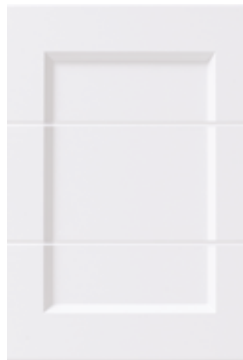

Drawer Bank



Laminex® FormWrap™ Accessories

Recessed Rails

Offering a seamless, sleek and minimal look, recessed rails allow you to apply a handle-free design to any of the FormWrap profiles.

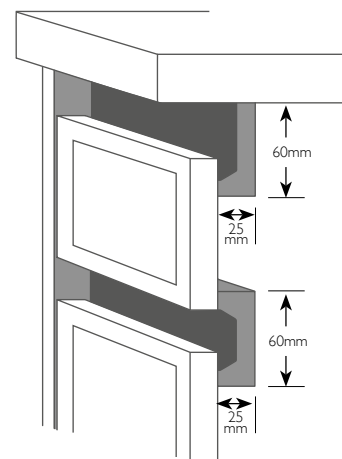
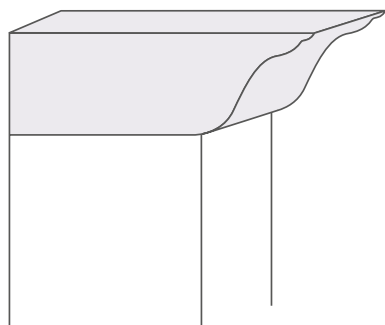

Capping Moulds

For a classic feature or seamless transition from overheads to ceiling, opt for our decorative capping mould and enhance the design of your kitchen.



Handle-free design
using recessed rails

Vanity top: Essastone in **Bitumen** Igneous finish in 20mm
Cabinetry: Laminex FormWrap doors in **White Satin** finish with a Classic 2mm profile.

Laminex® FormWrap™ Panel Options

For a complete kitchen design, Laminex® FormWrap offers various panel and shelving options from double-sided panels, return wrap panels as well as matching Laminex decorated panel range.

Matched Laminex Decorated Panel Range

Matching Laminex decorated panel can be incorporated as shelving, oven surrounds, kickers or end panels to provide a complementary and economical solution. Offered in the most popular Laminex FormWrap colours, this range has been specifically developed to match to the Laminex Colour Collection, ensuring seamless transitions from FormWrap Door to Laminex Decorated Panel.

FORMWRAP FINISH	MATCHED COLOURED BOARD FINISH
Textured	Flint
Gloss	Silk

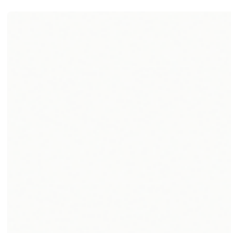

Polar White
SF

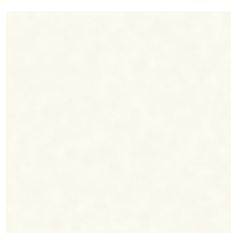

White
SF



Parchment
SF

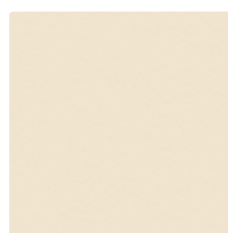

Moleskin
SF

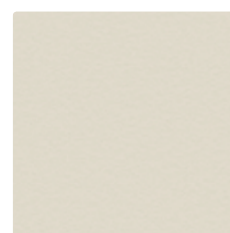

Sarsen Grey
SF

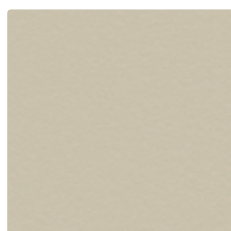

Paper Bark
SF

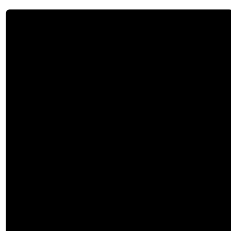

Black
F

Return Panels

FormWrap™ Return Panels* offer a continuous square edge on your vinyl wrapped panels. This option allows for the appearance of thicker panels, as well as providing your end panels, refrigerator and pantry panels a seamless look.

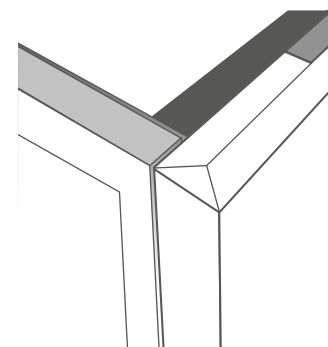

Shelving

Integrate shelving units into your kitchen build by utilising double-sided FormWrap Panels or the matching Laminex decorated panel range.

FINISH: F = Laminex Flint finish (ideal match to FormWrap Textured finish), SF = Laminex Silk Finish (ideal match to FormWrap Gloss finish), ^Natural finish is not a standard offer and attracts longer lead times. *Maximum Return Panel height of 3050mm.



Cabinetry: **Laminex FormWrap**,
doors in **White Satin** finish with a **Settler**.

Visit Us

For location of your closest showroom or more information visit [Laminex.com.au](https://www.laminex.com.au)

For design inspiration visit [Laminexdesignhub.com.au](https://www.laminexdesignhub.com.au)

Call Us

For trade enquiries call **132 136**

Product Sample

For a sample visit [Laminex.com.au](https://www.laminex.com.au)

Follow Us

 [facebook.com/Laminexau](https://www.facebook.com/Laminexau)

 [au.pinterest/Laminexau](https://www.pinterest.com/Laminexau)

 [instagram.com/Laminexau](https://www.instagram.com/Laminexau)

 [youtube.com/Laminexau](https://www.youtube.com/Laminexau)

Laminex FormWrap doors are marketed and distributed by Laminex Group Pty Limited ABN 98 004 093 092, trading as Laminex. In some cases, Laminex® uses computer generated imagery (CGI) to provide graphical representations of our products where actual photos are not available. The colours and finishes of the products featured within all Laminex imagery are as close to the Laminex range as CGI, photographic lighting and our printing processes allow. Different camera angles, although not designed to be misleading, can sometimes distort actual size and distances. Laminex FormWrap doors are no different than any other material in that darker colours will always show scratches and superficial wear and tear more readily than lighter colours. Laminex FormWrap doors should be protected from strong, direct sunlight as continuous exposure may cause discolouration or fading to the surface. Please obtain a copy of the terms and conditions of the Laminex Limited Product Warranty from [Laminex.com.au](https://www.laminex.com.au). This warranty is in addition to any rights that may exist under the Australian Consumer Law. Laminex® FormWrap™ doors, Essastone by Laminex®, Lamiwood.

LNx0079 | 11/18

Laminex®